



Dell™ Dimension™ 2400 Series

[Before You Begin](#)
[Turning Off Your Computer](#)
[Removing the Computer Cover](#)
[Technical Overview](#)
[Technical Specifications](#)
[Advanced Troubleshooting](#)
[System Setup Program](#)
[Removing and Installing Parts](#)
[Replacing the Computer Cover](#)

Notes, Notices, and Cautions

-  **NOTE:** A NOTE indicates important information that helps you make better use of your computer.
 -  **NOTICE:** A NOTICE indicates either potential damage to hardware or loss of data and tells you how to avoid the problem.
 -  **CAUTION:** A CAUTION indicates a potential for property damage, personal injury, or death.
-

Abbreviations and Acronyms

For a complete list of abbreviations and acronyms, see the [Tell Me How](#) help file.

If you purchased a Dell™ n Series computer, any references in this document to Microsoft® Windows® operating systems are not applicable.

Information in this document is subject to change without notice.
© 2003 - 2004 Dell Inc. All rights reserved.

Reproduction in any manner whatsoever without the written permission of Dell Inc. is strictly forbidden.

Trademarks used in this text: *Dell*, the *DELL* logo, and *Dimension* are trademarks of Dell Inc.; *Intel*, *Pentium*, and *Celeron* are registered trademarks of Intel Corporation; *Microsoft* and *Windows* are registered trademarks of Microsoft Corporation.

Other trademarks and trade names may be used in this document to refer to either the entities claiming the marks and names or their products. Dell Inc. disclaims any proprietary interest in trademarks and trade names other than its own.

August 2004 Rev. A03

Advanced Troubleshooting

Dell™ Dimension™ 2400 Series



- [Diagnostic Lights](#)
- [Beep Codes](#)
- [System Messages](#)

Diagnostic Lights

To help you troubleshoot a problem, your computer has four lights labeled "A," "B," "C," and "D" on the back panel. The lights can be yellow or green. When the computer starts normally, the lights flash. After the computer starts, all four lights display solid green. If the computer malfunctions, the color and sequence of the lights identify the problem.

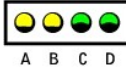
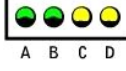
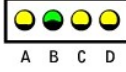
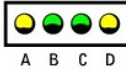
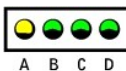
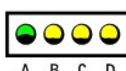
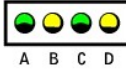
CAUTION: Before you begin any of the procedures in this section, follow the safety instructions in your *Owner's Manual* or *Product Information Guide*.

| Light Pattern | Problem Description | Suggested Resolution |
|--|--|--|
|  | The computer is in a normal off condition or a possible pre-BIOS failure has occurred. | Verify that the computer is plugged into a working electrical outlet and that you have pressed the power button. |
|  | Memory modules are detected, but a memory failure has occurred. | <ol style="list-style-type: none"> 1 If you have one memory module installed, reinstall it and restart the computer. 1 If you have two or more memory modules installed, remove the modules, reinstall one module, and then restart the computer. If the computer starts normally, reinstall an additional module. Continue until you have identified a faulty module or reinstalled all modules without error. 1 If available, install properly working memory of the same type into your computer. 1 If the problem persists, see "Contacting Dell" in your <i>Owner's Manual</i>. |
|   | A possible expansion card failure has occurred. | <ol style="list-style-type: none"> 1. Determine if a conflict exists by removing a card (not the video card) and then restarting the computer. 2. If the problem persists, reinstall the card that you removed, remove a different card, and then restart the computer. 3. Repeat this process for each card. If the computer starts normally, troubleshoot the last card removed from the computer for resource conflicts (see "Resolving Software and Hardware Incompatibilities" in your <i>Owner's Manual</i>). 4. If the problem persists, see "Contacting Dell" in your <i>Owner's Manual</i>. |
|  | A possible floppy or hard drive failure has occurred. | Reseat all power and data cables and restart the computer. |
|  | A possible USB failure has occurred. | Reinstall all USB devices, check cable connections, and then restart the computer. |
|  | No memory modules are detected. | <ol style="list-style-type: none"> 1 Reinstall all memory modules and restart the computer. 1 To eliminate the possibility of a faulty memory connector, remove all memory modules, reinstall one memory module (if the computer supports a single module), and then restart the computer. If the computer starts normally, move the memory module to a different connector and restart the computer. Continue until you have identified a faulty connector or reinstalled all modules without error. |
|  | Memory modules are detected, but a memory configuration or compatibility error exists. | <ol style="list-style-type: none"> 1 Ensure that no special memory module/memory connector placement requirements exist. 1 Verify that the memory modules that you are installing are compatible with your computer. 1 If the problem persists, see "Contacting Dell" in your <i>Owner's Manual</i>. |
| | Another failure has occurred. | <ol style="list-style-type: none"> 1 Ensure that the cables are properly connected to the system board from the hard drive, CD drive, and DVD drive. |

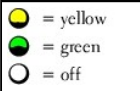
| | | |
|--|---|---|
|  A B C D | | 1. If the problem persists, see "Contacting Dell" in your <i>Owner's Manual</i> . |
|  A B C D | The computer is in a normal operating condition after POST. | None. |
|  = yellow = green = off | | |

Beep Codes

Your computer might emit a series of beeps during start-up if the monitor cannot display errors or problems. This series of beeps, called a beep code, identifies a problem. One possible beep code (code 1-3-1) consists of one beep, a burst of three beeps, and then one beep. This beep code tells you that the computer encountered a memory problem.

Reseating the memory modules may fix the beep code errors in the following table. If the problem persists, see "Contacting Dell" in your *Owner's Manual* for instructions on obtaining technical assistance.

| Code | Cause |
|---------------------|--|
| 1-3-1 through 2-4-4 | Memory not being properly identified or used |
| 4-3-1 | Memory failure above address 0FFFFh |

If you hear one of the following beep codes, see "Contacting Dell" in your *Owner's Manual* for instructions on obtaining technical assistance.

| Code | Cause |
|-------|--|
| 1-1-2 | Microprocessor register failure |
| 1-1-3 | NVRAM |
| 1-1-4 | ROM BIOS checksum failure |
| 1-2-1 | Programmable interval timer |
| 1-2-2 | DMA initialization failure |
| 1-2-3 | DMA page register read/write failure |
| 3-1-1 | Slave DMA register failure |
| 3-1-2 | Master DMA register failure |
| 3-1-3 | Master interrupt mask register failure |
| 3-1-4 | Slave interrupt mask register failure |
| 3-2-2 | Interrupt vector loading failure |
| 3-2-4 | Keyboard Controller Test failure |
| 3-3-1 | NVRAM power loss |
| 3-3-2 | NVRAM configuration |
| 3-3-4 | Video Memory Test failure |
| 3-4-1 | Screen initialization failure |
| 3-4-2 | Screen retrace failure |
| 3-4-3 | Search for video ROM failure |
| 4-2-1 | No time tick |
| 4-2-2 | Shutdown failure |
| 4-2-3 | Gate A20 failure |
| 4-2-4 | Unexpected interrupt in protected mode |
| 4-3-3 | Timer-chip counter 2 failure |
| 4-3-4 | Time-of-day clock stopped |
| 4-4-1 | Serial or parallel port test failure |
| 4-4-4 | Cache test failure |

System Messages

 **NOTE:** If the message you received is not listed in the table, see the documentation for either the operating system or the program that was running when the message appeared.

| Message | Possible Cause | Corrective Action |
|---|---|---|
| 8042 Gate-A20 error | The keyboard controller failed its test. | If you receive this message after you make changes in the system setup program , enter the program and restore the original value(s). |
| Address Line Short! | An error in the address decoding circuitry in the memory has occurred. | Reseat the memory modules. |
| C: Drive Error C: Drive Failure | The hard drive is not working or is not configured correctly. | Ensure that the drive is installed correctly in the computer and defined correctly in the system setup program . |
| Cache Memory Bad, Do Not Enable Cache | The cache memory is not operating. | See "Contacting Dell" in your <i>Owner's Manual</i> for instructions on obtaining technical assistance. |
| CH-2 Timer Error | An error is occurring on the timer on the system board. | See "Contacting Dell" in your <i>Owner's Manual</i> for instructions on obtaining technical assistance. |
| CMOS Battery State Low CMOS Checksum Failure CMOS System Options Not Set CMOS Display Type Mismatch CMOS Memory Size Mismatch CMOS Time and Date Not Set | The system configuration information in the system setup program is incorrect or the battery charge may be low. | Enter the system setup program , verify the system configuration, and then restart the computer. |
| Diskette Boot Failure | Drive A or B is present but has failed the BIOS POST. | Ensure that the drive is installed correctly in the computer and defined correctly in the system setup program . Check the interface cable at both ends. |
| DMA Error DMA 1 Error DMA 2 Error | Error in the DMA controller on the system board. | The keyboard or system board may need to be replaced. |
| FDD Controller Failure HDD Controller Failure | The BIOS cannot communicate with the floppy drive or hard drive controller. | Ensure that the floppy drive or the hard drive is installed correctly in the computer and defined correctly in the system setup program . Check the interface cable at both ends. |
| INTR1 Error INTR2 Error | An interrupt channel on the system board failed to POST. | The keyboard or system board may need to be replaced. |
| Invalid Boot Diskette | The operating system cannot be located on drive A or drive C. | Enter the system setup program and confirm that drive A or drive C is properly identified. |
| Keyboard Error | The BIOS has detected a stuck key. | Ensure that nothing is resting on the keyboard; if a key appears to be stuck, carefully pry it up. If the problem persists, you may need to replace the keyboard. |
| KB/Interface Error | An error occurred with the keyboard connector. | Ensure that nothing is resting on the keyboard; if a key appears to be stuck, carefully pry it up. If the problem persists, you may need to replace the keyboard. |
| No ROM Basic | The operating system cannot be located on drive A or drive C. | Enter the system setup program and confirm that drive A or drive C is properly identified. |

[Back to Contents Page](#)

Battery

Dell™ Dimension™ 2400 Series

⚠ CAUTION: Before you begin any of the procedures in this section, follow the safety instructions in your *Owner's Manual* or *Product Information Guide*.

A coin-cell battery maintains computer configuration, date, and time information. The battery can last several years.

If you have to repeatedly reset time and date information after turning on the computer, replace the battery.

⚠ CAUTION: A new battery can explode if it is incorrectly installed. Replace the 3-V CR2032 battery only with the same or equivalent type recommended by the manufacturer. Discard used batteries according to the manufacturer's instructions.

1. Record all the screens in the [system setup program](#) so that you can restore the correct settings when you perform [step 8](#).
2. [Remove the computer cover.](#)
3. [Locate the battery socket.](#)
4. Remove the battery by carefully prying it out of its socket with your fingers or with a blunt, nonconducting object such as a plastic screwdriver.

➡ NOTICE: To avoid damage to the system board while you pry the battery loose, be sure to insert the plastic screwdriver between the battery and the socket (not the system board).

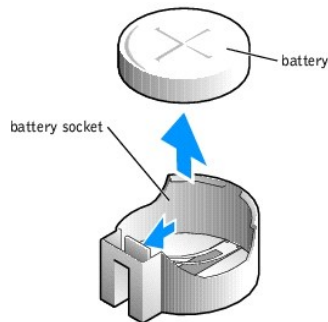

5. Insert the new battery into the socket with the side labeled "+" facing up and snap the battery into place.

➡ NOTICE: To connect a network cable, first plug the cable into the network wall jack and then plug it into the computer.

6. [Replace the computer cover.](#)
7. Connect your computer and devices to electrical outlets, and turn them on.
8. Access the [system setup program](#) and restore the settings you recorded in [step 1](#).
9. Properly dispose of the old battery. See the safety instructions in your *Owner's Manual* or *Product Information Guide*.

[Back to Contents Page](#)

Before You Begin

Dell™ Dimension™ 2400 Series

- [Recommended Tools](#)
- [Precautionary Measures](#)
- [Protecting Against Electrostatic Discharge](#)

This section provides procedures for removing and replacing the components. Unless otherwise noted, each procedure assumes that the following conditions exist:

- 1 You have performed the steps in "[Precautionary Measures](#)."
 - 1 You have read the safety information in your *Owner's Manual* or *Product Information Guide*.
 - 1 You have opened the computer cover.
-

Recommended Tools

Your computer is primarily a tool-less one, but certain procedures (such as removing the heat-sink blower or the control panel) require the use of one or more of the following tools:

- 1 Small flat-blade screwdriver
 - 1 #1 and #2 Phillips-head screwdriver
 - 1 An 8-inch, #2 Phillips-head screwdriver
-

Precautionary Measures

Use the following safety guidelines to help protect your computer from potential damage and to ensure your own personal safety.

 **CAUTION:** Before you begin any of the procedures in this section, follow the safety instructions in your *Owner's Manual* or *Product Information Guide*.

 **CAUTION:** Do not attempt to service the computer yourself, except as explained in your online Dell™ documentation or in instructions otherwise provided to you by Dell. Always follow installation and service instructions closely.

 **NOTICE:** To help avoid possible damage to the system board, wait 5 seconds (or wait until the standby light is extinguished) after turning off the computer and unplugging the power cable before removing a component from the system board or disconnecting a device from the computer.

Before you start to work on the computer, perform the following steps in the sequence listed:

1. [Shut down the computer](#) through the **Start** menu.
2. Ensure that your computer and attached devices are turned off. If your computer and attached devices did not automatically turn off when you shut down your computer, turn them off now.

 **NOTICE:** To disconnect a network cable, first unplug the cable from your computer and then unplug it from the network wall jack.

3. Disconnect any telephone or telecommunication lines from the computer.
4. Disconnect your computer and all attached devices from electrical outlets, and then press the power button to ground the system board.

 **NOTICE:** Before touching anything inside your computer, ground yourself by touching an unpainted metal surface, such as the metal at the back of the computer. While you work, periodically touch an unpainted metal surface to dissipate any static electricity that could harm internal components.

In addition, take note of these safety guidelines when appropriate:

- 1 When you disconnect a cable, pull on its connector or on its strain-relief loop, not on the cable itself. Some cables have a connector with locking tabs; if you are disconnecting this type of cable, press in on the locking tabs before disconnecting the cable. As you pull connectors apart, keep them evenly

aligned to avoid bending any connector pins. Also, before you connect a cable, ensure that both connectors are correctly oriented and aligned.

- 1 Handle components and cards with care. Do not touch the components or contacts on a card. Hold a card by its edges or by its metal mounting bracket. Hold a component such as a microprocessor chip by its edges, not by its pins.
-

Protecting Against Electrostatic Discharge

Static electricity can harm delicate components inside your computer. To prevent static damage, discharge static electricity from your body before you touch any of your computer's electronic components, such as the microprocessor. You can do so by touching an unpainted metal surface on the computer chassis.

As you continue to work inside the computer, periodically touch an unpainted metal surface to remove any static charge your body may have accumulated.

You can also take the following steps to prevent damage from electrostatic discharge (ESD):

- 1 When unpacking a static-sensitive component from its shipping carton, do not remove the component from the antistatic packing material until you are ready to install the component in your computer. Just before unwrapping the antistatic packaging, be sure to discharge static electricity from your body.
 - 1 When transporting a sensitive component, first place it in an antistatic container or packaging.
 - 1 Handle all sensitive components in a static-safe area. If possible, use antistatic floor pads and workbench pads.
-

[Back to Contents Page](#)

Cards

Dell™ Dimension™ 2400 Series

⚠ CAUTION: Before you begin any of the procedures in this section, follow the safety instructions in your *Owner's Manual* or *Product Information Guide*.

1. [Shut down the computer](#) through the **Start** menu.
2. Ensure that your computer and attached devices are turned off. If your computer and attached devices did not automatically turn off when you shut down your computer, turn them off now.

🔄 NOTICE: To disconnect a network cable, first unplug the cable from your computer and then unplug it from the network wall jack.

3. Disconnect any telephone or telecommunication lines from the computer.
4. Disconnect your computer and all attached devices from their electrical outlets, and then press the power button to ground the system board.

⚠ CAUTION: To guard against electrical shock, always unplug your computer from the electrical outlet before opening the cover.

5. [Remove the computer cover](#).
6. Lay the computer on its side so that the system board is on the bottom of the inside of the computer.
7. Unscrew and remove the filler bracket for the card slot you want to use.

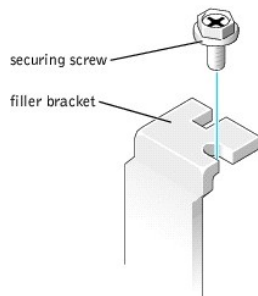

⚠ CAUTION: Some network adapters automatically start the computer when they are connected to a network. To guard against electrical shock, be sure to unplug your computer from its electrical outlet before installing any cards.

8. Align the cutout on the bottom of the card with the crossbar in the system board connector. Gently rock the card into the connector until it is fully seated.

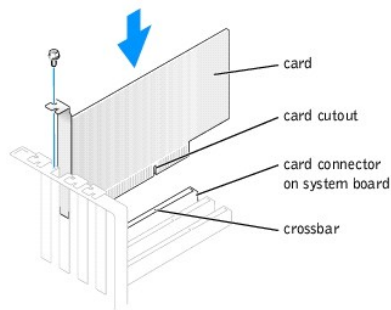

Ensure that the card is fully seated and that its bracket is within the card slot.

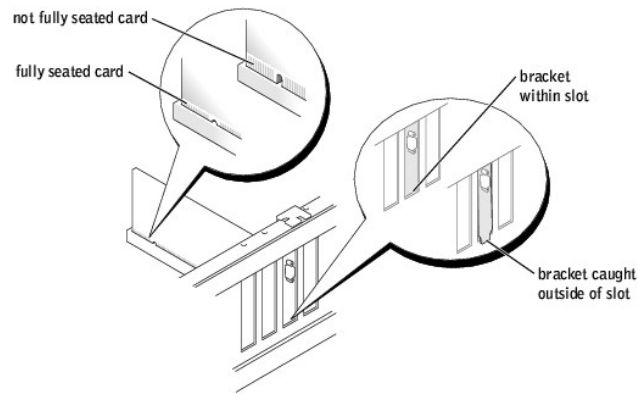

9. Secure the filler bracket onto the end of the card with the screw you removed in [step 7](#).
10. Connect any cables that should be attached to the card.

See the documentation for the card for information about the card's cable connections.

➔ **NOTICE:** Do not route card cables over or behind the cards. Cables routed over the cards can cause damage to the equipment.

11. [Replace the computer cover.](#)

➔ **NOTICE:** To connect a network cable, first plug the cable into the network wall jack and then plug it into the computer.

12. Connect your computer and devices to electrical outlets, and turn them on.
13. Install any drivers required for the card as described in the card documentation.

[Back to Contents Page](#)

Drives

Dell™ Dimension™ 2400 Series

- [Adding a Floppy Drive](#)
 - [Adding or Replacing a CD or DVD Drive](#)
 - [Replacing a Hard Drive](#)
-

Adding a Floppy Drive

CAUTION: Before you begin any of the procedures in this section, follow the safety instructions in your *Owner's Manual* or *Product Information Guide*.

1. [Shut down the computer](#) through the **Start** menu.
2. Ensure that your computer and attached devices are turned off. If your computer and attached devices did not automatically turn off when you shut down your computer, turn them off now.

NOTICE: To disconnect a network cable, first unplug the cable from your computer and then unplug it from the network wall jack.

3. Disconnect any telephone or telecommunication lines from the computer.
4. Disconnect your computer and all attached devices from their electrical outlets, and then press the power button to ground the system board.

CAUTION: To guard against electrical shock, always unplug your computer from the electrical outlet before opening the cover.

5. [Remove the computer cover](#).
6. [Release and remove the front panel](#).
7. [Remove the front-panel insert](#).
8. Connect the floppy-drive power cable to the back of the drive.

CAUTION: Match the colored strip on the cable with pin 1 on the drive (pin 1 is marked as "1").

9. Connect the data cable to the back of the drive and to the floppy drive connector on the [system board](#).
10. Position the top of the floppy drive bracket so that it is completely flush with the bottom of the lower drive bay, and then slide the floppy drive bracket forward into place.

NOTE: The top of the floppy drive bracket has two slots that fit into two clips on the bottom of the upper drive bay. When the floppy drive bracket is properly mounted, it remains in place without support.

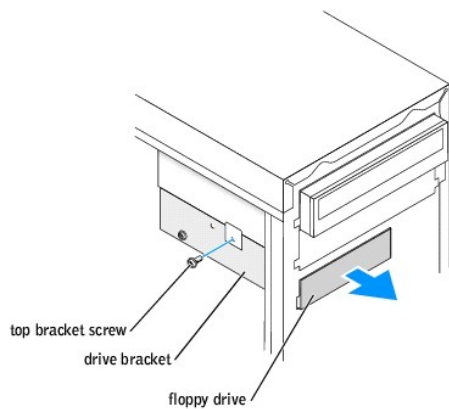

11. Secure the floppy drive bracket with the top bracket screw that came with your drive.
12. [Reattach the front panel](#).

13. Check all cable connections, and fold cables out of the way to provide airflow for the fan and cooling vents.
14. [Replace the computer cover.](#)

 **NOTICE:** To connect a network cable, first plug the cable into the network wall jack and then plug it into the computer.

15. Connect your computer and devices to electrical outlets, and turn them on.
 16. After you turn on your computer, press <F2> when you are prompted to enter setup mode.
 17. Highlight **Drive Configuration** and press <Enter>.
 18. Use the left and right arrows to change **Diskette Drive A** from **Not Installed** to **3.5 inch, 1.44 MB**.
 19. Press <Enter>.
 20. Highlight **Integrated Devices (LegacySelect Options)** and press <Enter>.
 21. Make sure that the **Diskette Interface** entry is set to **Auto**. If necessary, use the left and right arrows to set it to **Auto**.
 22. Press <Enter>.
 23. Press <Esc>.
 24. Press <Enter> to save changes and exit.
The computer restarts.
 25. See the documentation that came with the drive for instructions on installing any software required for drive operation.
-

Adding or Replacing a CD or DVD Drive

 **CAUTION:** Before you begin any of the procedures in this section, follow the safety instructions in your *Owner's Manual* or *Product Information Guide*.

1. [Shut down the computer](#) through the **Start** menu.

 **NOTE:** Drives sold by Dell come with their own operating software and documentation. After you install a drive, see the documentation that came with the drive for instructions on installing and using the drive software.

2. Ensure that your computer and attached devices are turned off. If your computer and attached devices did not automatically turn off when you shut down your computer, turn them off now.

 **NOTICE:** To disconnect a network cable, first unplug the cable from your computer and then unplug it from the network wall jack.

3. Disconnect any telephone or telecommunication lines from the computer.
4. Disconnect your computer and all attached devices from their electrical outlets, and then press the power button to ground the system board.

 **CAUTION:** To guard against electrical shock, always unplug your computer from the electrical outlet before opening the cover.

5. [Remove the computer cover.](#)
6. [Release and remove the front panel.](#)
7. [Remove the front-panel insert.](#)
8. Ensure that the jumper setting on the new drive is set for "cable select" (see the documentation that came with the drive for information).

 **NOTE:** Some computers come with only two alignment screws; others come with four. You only need two alignment screws for this procedure.

9. Remove the two alignment screws, shown in the following figure, from the front of the computer and insert them into the drive.

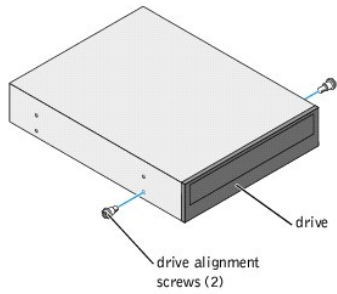

10. Gently slide the drive into place.

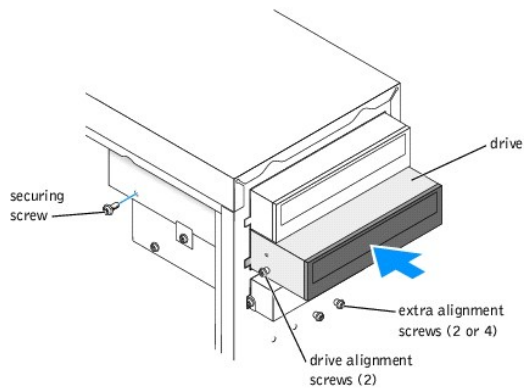

11. Once the drive is in place, apply pressure to ensure that the drive is fully seated.
12. Use the securing screw that came with the drive to attach the drive to the computer.

⚠ CAUTION: Match the colored strip on the cable with pin 1 on the drive (pin 1 is marked as "1").

13. Connect the power cable to the system board.
14. Locate the data cable from the CD or DVD drive in the upper drive bay and connect its middle data connector to the new drive.
15. Check all cable connections, and then fold the cables out of the way to provide airflow for the fan and cooling vents.
16. [Reattach the front panel.](#)
17. [Replace the computer cover.](#)

🔗 NOTICE: To connect a network cable, first plug the cable into the network wall jack and then plug it into the computer.

18. Connect your computer and devices to electrical outlets, and then turn them on.

See the documentation that came with the drive for instructions on installing any software required for drive operation.

Replacing a Hard Drive

⚠ CAUTION: Before you begin any of the procedures in this section, follow the safety instructions in your *Owner's Manual* or *Product Information Guide*.

⚠ CAUTION: To avoid damage to the drive, do not set it on a hard surface. Instead, set the drive on a soft surface, such as a foam pad, that will sufficiently cushion it.

1. [Shut down the computer](#) through the **Start** menu.
2. Ensure that your computer and attached devices are turned off. If your computer and attached devices did not automatically turn off when you shut down your computer, turn them off now.

➡ **NOTICE:** To disconnect a network cable, first unplug the cable from your computer and then unplug it from the network wall jack.

3. Disconnect any telephone or telecommunication lines from the computer.
4. Disconnect your computer and all attached devices from their electrical outlets, and then press the power button to ground the system board.

⚠ **CAUTION:** To guard against electrical shock, always unplug your computer from the electrical outlet before opening the cover.

5. [Remove the computer cover.](#)

➡ **NOTICE:** Before touching anything inside your computer, ground yourself by touching an unpainted metal surface, such as the metal at the back of the computer. While you work, periodically touch an unpainted metal surface to dissipate any static electricity that could harm internal components.

6. Remove the hard drive:
 - a. Disconnect the power and hard-drive cables from the drive.
 - b. Remove the bracket-securing screw, and then remove the drive bracket from the computer.
 - c. Remove the three hard drive-securing screws, and then remove the hard drive from the bracket.

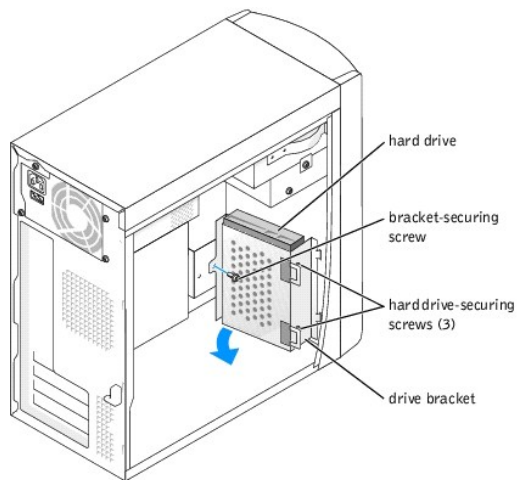

➡ **NOTICE:** Ground yourself by touching an unpainted metal surface on the back of the computer.

➡ **NOTICE:** When you unpack the drive, do not set it on a hard surface, which may damage the drive. Instead, set the drive on a soft surface, such as a foam pad, that will sufficiently cushion it.

7. Unpack the replacement hard drive.
8. Check the jumper setting on the back of the replacement drive.

Ensure that the jumper setting on the new device is set for "cable select" (see the documentation that came with the drive for information).

9. Install the hard drive:
 - a. Place the hard drive in the bracket so that all three screw-hole tabs insert into the three screw holes on the hard drive.
 - b. Secure the drive to the bracket with the hard drive-securing screws that you removed in [step 6](#).
 - c. Install the bracket into the computer with the bracket-securing screw that you removed in [step 6](#).

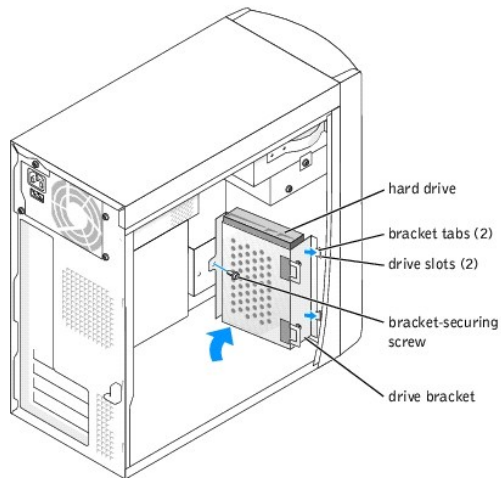

⚠ CAUTION: Match the colored strip on the cable with pin 1 on the drive (pin 1 is marked as "1").

10. Connect the power and data cables to the back of the replacement drive.
11. [Replace the computer cover.](#)

➡ NOTICE: To connect a network cable, first plug the cable into the network wall jack and then plug it into the computer.

12. Connect your computer and devices to electrical outlets, and turn them on.
13. See the documentation that came with the drive for instructions on installing any software required for drive operation.

Front Panel

Dell™ Dimension™ 2400 Series

- [Removing the Front Panel](#)
- [Replacing the Front Panel](#)
- [Removing the Front-Panel Insert](#)

Removing the Front Panel

⚠ CAUTION: Before you begin any of the procedures in this section, follow the safety instructions in your *Owner's Manual* or *Product Information Guide*.

1. [Shut down the computer](#) through the **Start** menu.
2. Ensure that your computer and attached devices are turned off. If your computer and attached devices did not automatically turn off when you shut down your computer, turn them off now.

➡ NOTICE: To disconnect a network cable, first unplug the cable from your computer and then unplug it from the network wall jack.

3. Disconnect any telephone or telecommunication lines from the computer.
4. Disconnect your computer and all attached devices from their electrical outlets, and then press the power button to ground the system board.

⚠ CAUTION: To guard against electrical shock, always unplug your computer from the electrical outlet before opening the cover.

5. [Remove the computer cover](#).

➡ NOTICE: Before touching anything inside your computer, ground yourself by touching an unpainted metal surface, such as the metal at the back of the computer. While you work, periodically touch an unpainted metal surface to dissipate any static electricity that could harm internal components.

6. Release and remove the front panel:
 - a. Push the release lever to release the top tab.
 - b. Reach inside the computer and push the bottom tab towards you to release it (the middle tab releases automatically).
 - c. Rotate the front panel to separate it from the side hinges.

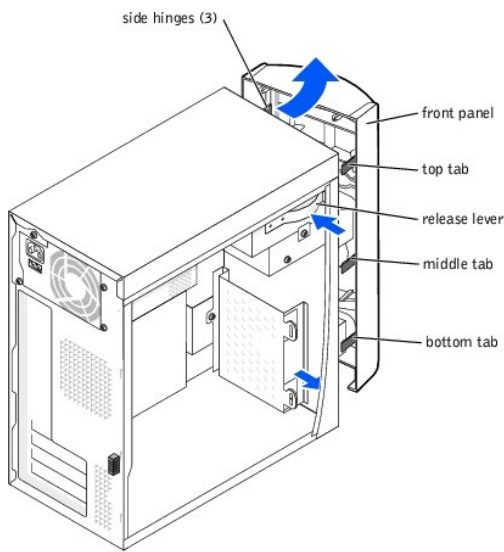

Replacing the Front Panel

To replace the front panel, attach the side hinges and then rotate the front panel until it snaps onto the front of the computer.

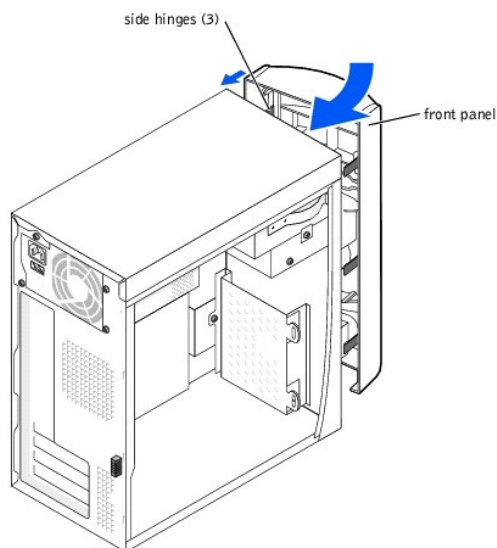

Removing the Front-Panel Insert

⚠ CAUTION: Before you begin any of the procedures in this section, follow the safety instructions in your *Owner's Manual* or *Product Information Guide*.

1. [Shut down the computer](#) through the **Start** menu.
2. Ensure that your computer and attached devices are turned off. If your computer and attached devices did not automatically turn off when you shut down your computer, turn them off now.

➡ NOTICE: To disconnect a network cable, first unplug the cable from your computer and then unplug it from the network wall jack.

3. Disconnect any telephone or telecommunication lines from the computer.
4. Disconnect your computer and all attached devices from their electrical outlets, and then press the power button to ground the system board.

⚠ CAUTION: To guard against electrical shock, always unplug your computer from the electrical outlet before opening the cover.

5. [Remove the computer cover](#).

➡ NOTICE: Before touching anything inside your computer, ground yourself by touching an unpainted metal surface, such as the metal at the back of the computer. While you work, periodically touch an unpainted metal surface to dissipate any static electricity that could harm internal components.

6. [Remove the front panel](#).
7. Press in the two insert tabs, and then push out the front-panel insert.

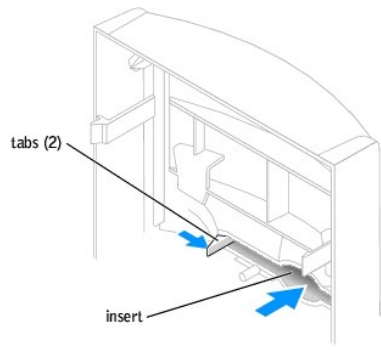

[Back to Contents Page](#)

Memory

Dell™ Dimension™ 2400 Series

- [Installing Memory](#)
- [Removing Memory](#)

You can increase your computer memory by installing memory modules on the system board. For information on the type of memory supported by your computer, see "[Memory](#)."

Installing Memory

⚠ CAUTION: Before you begin any of the procedures in this section, follow the safety instructions in your *Owner's Manual* or *Product Information Guide*.

1. [Shut down the computer](#) through the **Start** menu.
2. Ensure that your computer and attached devices are turned off. If your computer and attached devices did not automatically turn off when you shut down your computer, turn them off now.

🔄 NOTICE: To disconnect a network cable, first unplug the cable from your computer and then unplug it from the network wall jack.

3. Disconnect any telephone or telecommunication lines from the computer.
4. Disconnect your computer and all attached devices from their electrical outlets, and then press the power button to ground the system board.

⚠ CAUTION: To guard against electrical shock, always unplug your computer from the electrical outlet before opening the cover.

5. [Remove the computer cover](#).
6. Press out the securing clip at each end of the memory module connector.

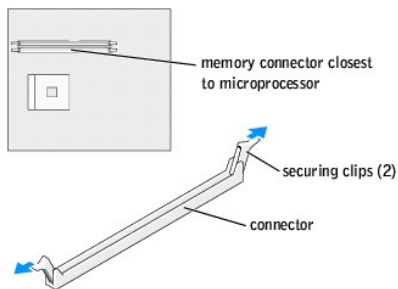

7. Align the notch on the bottom of the module with the crossbar in the connector.

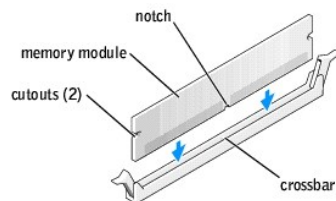

🔄 NOTICE: To avoid damage to the memory module, press the module straight down into the connector while you apply equal force to each end of the module.

8. Insert the module into the connector until the module snaps into position.

If you insert the module correctly, the securing clips snap into the cutouts at each end of the module.

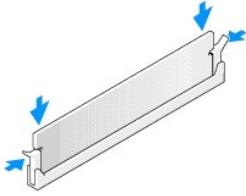

9. [Replace the computer cover.](#)

🔗 **NOTICE:** To connect a network cable, first plug the cable into the network wall jack and then plug it into the computer.

10. Connect your computer and devices to electrical outlets, and turn them on.
11. Right-click the **My Computer** icon and click **Properties**.
12. Click the **General** tab.
13. To verify that the memory is installed correctly, check the amount of memory (RAM) listed.

Removing Memory

⚠ **CAUTION:** Before you begin any of the procedures in this section, follow the safety instructions in your *Owner's Manual* or *Product Information Guide*.

📄 **NOTE:** Memory purchased from Dell is covered under your computer warranty.

1. [Shut down the computer](#) through the **Start** menu.
2. Ensure that your computer and attached devices are turned off. If your computer and attached devices did not automatically turn off when you shut down your computer, turn them off now.

🔗 **NOTICE:** To disconnect a network cable, first unplug the cable from your computer and then unplug it from the network wall jack.

3. Disconnect any telephone or telecommunication lines from the computer.
4. Disconnect your computer and all attached devices from their electrical outlets, and then press the power button to ground the system board.

⚠ **CAUTION:** To guard against electrical shock, always unplug your computer from the electrical outlet before opening the cover.

5. [Remove the computer cover.](#)
6. Press out the securing clip at each end of the memory module connector.
7. Grasp the module and pull up.

If the module is difficult to remove, gently ease the module back and forth to remove it from the connector.

[Back to Contents Page](#)

Microprocessor

Dell™ Dimension™ 2400 Series

- [Removing the Microprocessor](#)
 - [Installing the Microprocessor](#)
-

Removing the Microprocessor

⚠ CAUTION: Before you begin any of the procedures in this section, follow the safety instructions in your *Owner's Manual* or *Product Information Guide*.

1. [Shut down the computer](#) through the **Start** menu.
2. Ensure that your computer and attached devices are turned off. If your computer and attached devices did not automatically turn off when you shut down your computer, turn them off now.

➡ NOTICE: To disconnect a network cable, first unplug the cable from your computer and then unplug it from the network wall jack.

3. Disconnect any telephone or telecommunication lines from the computer.
4. Disconnect your computer and all attached devices from their electrical outlets, and then press the power button to ground the system board.

⚠ CAUTION: To guard against electrical shock, always unplug your computer from the electrical outlet before you open the cover.

5. [Remove the computer cover](#).

➡ NOTICE: Before touching anything inside your computer, ground yourself by touching an unpainted metal surface, such as the metal at the back of the computer. While you work, periodically touch an unpainted metal surface to dissipate any static electricity that could harm internal components.

6. Disconnect the cooling fan power cable from the fan connector (J30) on the [system board](#).
7. Disconnect the power cable from the microprocessor power connector (J21) on the [system board](#).
8. Lift the air shroud to disengage the anchors and then rotate the shroud up.

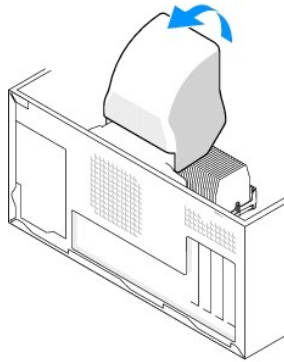

⚠ CAUTION: The heat sink can get very hot during normal operation. Be sure that the heat sink has had sufficient time to cool before you touch it.

9. Remove the microprocessor heat sink:
 - a. Twist the heat sink from side to side to break the seal.
 - b. Remove the retention module clip by pressing in on the tab and lifting the retention module clip up.
 - c. Pull the release tab out until the heat sink is released.
 - d. Lift the heat sink away from the microprocessor.

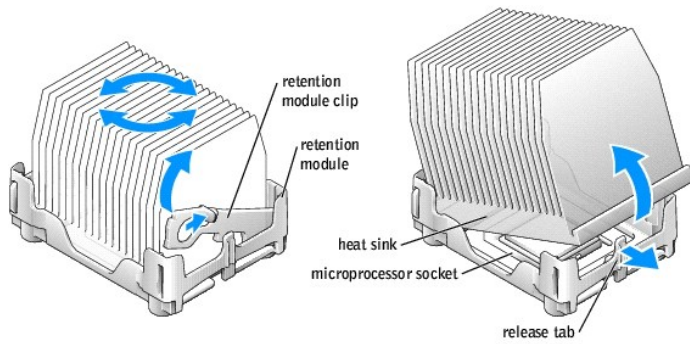

➔ **NOTICE:** Lay the heat sink down with the thermal grease facing upward.

➔ **NOTICE:** If you are installing a microprocessor upgrade kit from Dell, discard the original heat sink. If you are *not* installing a microprocessor upgrade kit from Dell, reuse the original heat sink when you install your new microprocessor.

➔ **NOTICE:** Be careful not to bend any of the pins when you remove the microprocessor from the socket. Bending the pins can permanently damage the microprocessor.

10. Remove the microprocessor from the socket.

Leave the release lever extended in the release position so that the socket is ready for the new microprocessor.

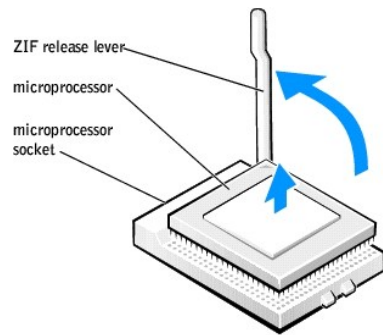

Installing the Microprocessor

➔ **NOTICE:** Ground yourself by touching an unpainted metal surface on the back of the computer.

➔ **NOTICE:** Be careful not to bend any of the pins when you unpack the microprocessor. Bending the pins can permanently damage the microprocessor. If any of the pins on the microprocessor appears to be bent, see "Contacting Dell" in the *Owner's Manual* for instructions on obtaining technical assistance.

1. Unpack the new microprocessor.

➔ **NOTICE:** You must position the microprocessor correctly in the socket to avoid permanent damage to the microprocessor and the computer when you turn on the computer.

2. If the release lever on the socket is not fully extended, move it to that position.

3. Align the pin-1 corners of the microprocessor and socket.

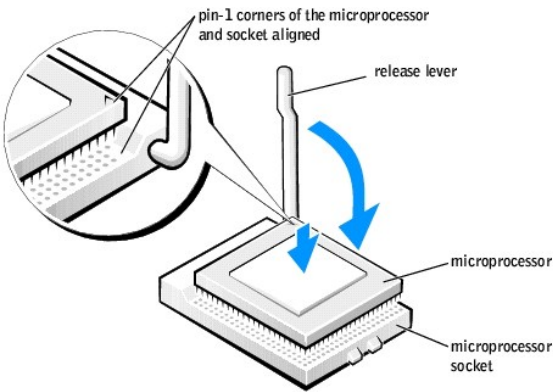

➔ **NOTICE:** When you place the microprocessor in the socket, ensure that all of the pins fit into the corresponding holes on the socket.

4. Set the microprocessor lightly in the socket and ensure that all pins are headed into the correct holes. Do not use force, which could bend the pins if the microprocessor is misaligned. When the microprocessor is positioned correctly, press it with minimal pressure to seat it.
5. When the microprocessor is fully seated in the socket, pivot the release lever back toward the socket until it snaps into place to secure the microprocessor.

➔ **NOTICE:** If you are *not* installing a microprocessor upgrade kit from Dell, reuse the original heat sink assembly when you replace the microprocessor.

If you installed a microprocessor replacement kit from Dell, return the original heat sink assembly and microprocessor to Dell in the same package in which your replacement kit was sent.

6. Install the heat sink:
 - a. Insert the notched end of the heat sink onto the end of the retention module which is next to the power supply.
 - b. Lower the heat sink until it fits securely in the module.
 - c. When the heat sink is secured, pivot the retention module clip down until the tab snaps into place to secure the heat sink.

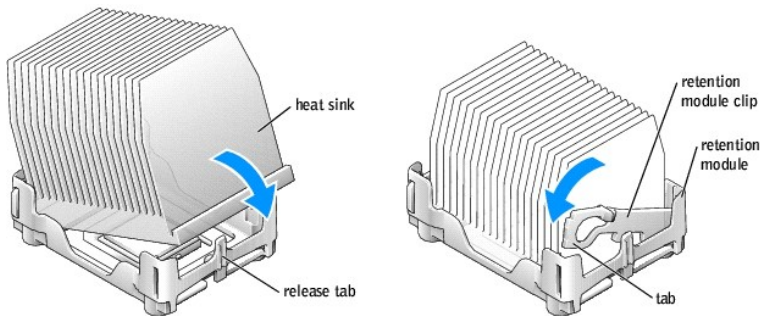

7. Lower the airflow shroud over the heat sink.
8. Reconnect the cooling fan power cable to the fan connector (J30) on the [system board](#).
9. Reconnect the power cable to the microprocessor power connector (J21) on the [system board](#).
10. [Replace the computer cover](#).

➔ **NOTICE:** To connect a network cable, first plug the cable into the network wall jack and then plug it into the computer.

11. Connect your computer and devices to electrical outlets, and turn them on.

[Back to Contents Page](#)

Removing and Installing Parts

Dell™ Dimension™ 2400 Series

- [Cards](#)
- [Memory](#)
- [Front Panel](#)
- [Drives](#)
- [Microprocessor](#)
- [System Board](#)
- [Power Supply](#)
- [Battery](#)

[Back to Contents Page](#)

Power Supply

Dell™ Dimension™ 2400 Series

- [Removing the Power Supply](#)
 - [Replacing the Power Supply](#)
-

Removing the Power Supply

⚠ CAUTION: Before you begin any of the procedures in this section, follow the safety instructions in your *Owner's Manual* or *Product Information Guide*.

1. [Shut down the computer](#) through the **Start** menu.
2. Ensure that your computer and attached devices are turned off. If your computer and attached devices did not automatically turn off when you shut down your computer, turn them off now.

➡ NOTICE: To disconnect a network cable, first unplug the cable from your computer and then unplug it from the network wall jack.

3. Disconnect any telephone or telecommunication lines from the computer.
4. Disconnect your computer and all attached devices from their electrical outlets, and then press the power button to ground the system board.

⚠ CAUTION: To guard against electrical shock, always unplug your computer from the electrical outlet before opening the cover.

5. [Remove the computer cover](#).

➡ NOTICE: Before touching anything inside your computer, ground yourself by touching an unpainted metal surface, such as the metal at the back of the computer. While you work, periodically touch an unpainted metal surface to dissipate any static electricity that could harm internal components.

6. Remove the fan assembly.
7. Disconnect the AC power cable from the AC power connector on the back of the power supply.
8. Unplug the DC power cables from the drives and system board.
9. Remove the four screws that secure the power supply to the back of the computer.

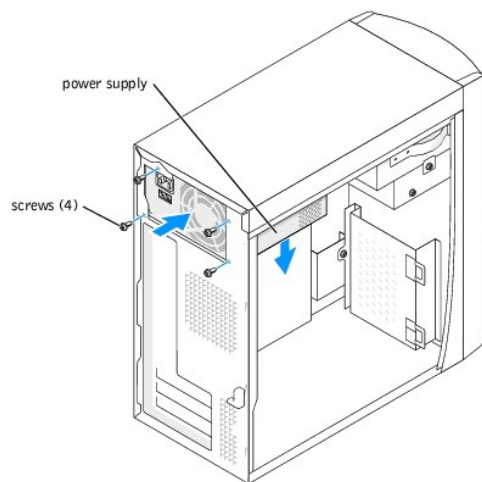

10. Remove the power supply from the computer.
-

Replacing the Power Supply

1. Slide the power supply into place.
2. Replace the four screws that secure the power supply to the back of the computer.
3. Reinstall the fan assembly.
4. Reconnect the DC power cables to the drives and system board.
5. [Replace the computer cover.](#)
6. Connect the AC power cable to the AC power connector on the back of the power supply.

 **NOTICE:** To connect a network cable, first plug the cable into the network wall jack and then plug it into the computer.

7. Connect your computer and devices to electrical outlets, and turn them on.

[Back to Contents Page](#)

[Back to Contents Page](#)

Replacing the Computer Cover

Dell™ Dimension™ 2400 Series

1. Ensure that all cables are connected, and fold cables out of the way.
2. Ensure that no tools or extra parts are left inside the computer.
3. Place the cover on the computer.
4. Slide the cover towards the front of the computer until it fits completely into place.

 **NOTICE:** To connect a network cable, first plug the cable into the network wall jack and then plug it into the computer.

5. Connect your computer and devices to electrical outlets, and turn them on.
-

[Back to Contents Page](#)

Removing the Computer Cover

Dell™ Dimension™ 2400 Series

⚠ CAUTION: Before you begin any of the procedures in this section, follow the safety instructions in your *Owner's Manual* or *Product Information Guide*.

1. [Shut down the computer](#) through the **Start** menu.
2. Ensure that your computer and attached devices are turned off. If your computer and attached devices did not automatically turn off when you shut down your computer, turn them off now.

🔌 NOTICE: To disconnect a network cable, first unplug the cable from your computer and then unplug it from the network wall jack.

3. Disconnect any telephone or telecommunication lines from the computer.
4. Disconnect your computer and all attached devices from their electrical outlets, and then press the power button to ground the system board.

⚠ CAUTION: To guard against electrical shock, always unplug your computer from the electrical outlet before opening the cover.

5. Lay your computer on its side with the computer cover facing up.
6. If your computer cover has a cover latch, slide and hold the cover latch.
7. Grip the indents on the computer cover, and slide the computer cover toward the back of the computer.

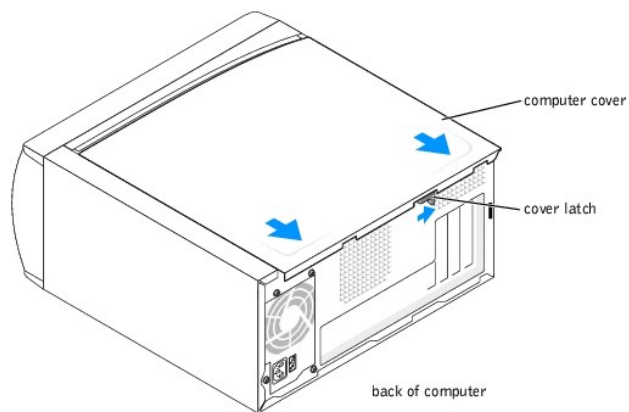

8. Place the computer cover on a level surface.

Technical Specifications

Dell™ Dimension™ 2400 Series

| Microprocessor | |
|---------------------|--|
| Microprocessor type | Intel® Pentium® 4 that runs at 2.2 or 2.4 GHz internally and 400 MHz externally, or 2.266, 2.4, 2.53, 2.66, 2.8, or 3.06 GHz internally and 533 MHz externally. Intel Celeron® that runs at 2.0, 2.2, 2.3, 2.4, 2.5, 2.6, or 2.7 GHz internally and 400 MHz externally. |
| L1 cache | 8 KB first-level (Pentium 4 and Celeron). |
| L2 cache | 256- or 512-KB (displayed in the system setup program) pipelined-burst, eight-way set associative, write-back SRAM (Pentium 4); 128-KB SRAM that resides in the processor's core. The L2 cache runs at the processor's internal clock speed (Celeron). |

| System Information | |
|--------------------|---------------------------|
| System chip set | Intel 845GV |
| DMA channels | eight |
| Interrupt levels | 24 APIC mode |
| System BIOS chip | 4 MB (512 KB) |
| System clock | 400- or 533-MHz data rate |

| Expansion Bus | |
|------------------------------------|-------------|
| Bus types | PCI |
| Bus speed | PCI: 33 MHz |
| PCI connectors | three |
| PCI connector size | 120 pins |
| PCI connector data width (maximum) | 32 bits |

| Memory | |
|-------------------|--|
| Architecture | DDR SDRAM |
| Memory connectors | two |
| Memory capacities | 128-, 256-, or 512-MB |
| Minimum memory | 128 MB shared DDR SDRAM <i>NOTE: Between 32 and 64 MB of system memory may be allocated to support graphics, depending on system memory size and other factors.</i> |
| Maximum memory | 2 GB |
| Memory type | PC2100 (266-MHz) or PC2700 (333-MHz) DDR SDRAM (non-ECC) |

| Drives | |
|-----------------------|--|
| Externally accessible | two 5.25-inch bays one 3.5-inch bay |
| Internally accessible | one bay for 1-inch-high IDE hard drive |

| Ports and Connectors | |
|------------------------|------------------------------------|
| Externally accessible: | |
| Serial | 9-pin connector; 16550C-compatible |
| Parallel | 25-hole connector (bidirectional) |
| Video | 15-hole connector |
| Keyboard | 6-pin mini-DIN connector |

| | |
|-------------------------|---|
| Mouse | 6-pin mini-DIN connector |
| USB | two front-panel and four back-panel USB 2.0-compliant connectors |
| Network | RJ-45 connector |
| Audio | three back miniature connectors for line-in, line-out, and microphone |
| Headphone | one front miniature connector for line-out |
| Internally accessible: | |
| Primary IDE channel | 40-pin connector on PCI local bus |
| Secondary IDE channel | 40-pin connector on PCI local bus |
| Floppy drive (optional) | 34-pin connector |

| | |
|------------------|--------------------------------------|
| Video | |
| Video controller | integrated Intel 3D Extreme Graphics |

| | |
|------------------|------------------|
| Audio | |
| Audio controller | integrated audio |

| | |
|--------------------|----------------------------|
| Network | |
| Network controller | integrated 10/100 Ethernet |

| | |
|----------------------------|--|
| Controls and Lights | |
| Power control | push button |
| Front-panel power light | solid green for power-on state; blinking green for standby state |
| Hard-drive access light | green |

| | |
|--|--|
| Power | |
| DC power supply: | |
| Wattage | 200 W or 250 W |
| Heat dissipation | 682 or 853 BTU (fully-loaded computer without monitor) |
| Voltage (see your <i>Owner's Manual</i> for important voltage setting information) | 100 to 120 V at 60 Hz; 200 to 240 V at 50 Hz |
| Backup battery | 3-V CR2032 coin cell |

| | |
|------------------------|---|
| Physical | |
| Height x Width x Depth | 36.8 x 18.4 x 42.6 cm (14.5 x 7.25 x 16.75 inches) |
| Weight | 10.4 kg (23 lb) |

| | |
|-----------------------------------|--|
| Environmental | |
| Temperature: | |
| Operating | 10° to 35°C (50° to 95°F) <i>NOTE: At 35°C (95°F), the maximum operating altitude is 914 m (3000 ft).</i> |
| Storage | -40° to 65°C (-40° to 149°F) |
| Relative humidity | 20% to 80% (noncondensing) |
| Maximum vibration: | |
| Operating | 0.25 G at 3 to 200 Hz |
| Storage | 2.20 Grms at 10 to 500 Hz |
| Maximum shock: | |
| Nonoperating (half-sine pulse) | 105 G, 2 ms |
| Nonoperating (faired-square wave) | 32 G with a velocity change of 596.9 cm/sec (235 inches/sec) |
| Altitude: | |
| Operating | -15.2 to 3048 m (-50 to 10,000 ft) |

| | |
|---------|---|
| | <i>NOTE: At 35°C (95°F), the maximum operating altitude is 914 m (3000 ft).</i> |
| Storage | -15.2 to 10,670 m (-50 to 35,000 ft) |

[Back to Contents Page](#)

System Board

Dell™ Dimension™ 2400 Series

- [Removing the System Board](#)
 - [Installing the System Board](#)
-

Removing the System Board

 **CAUTION:** Before you begin any of the procedures in this section, follow the safety instructions in your *Owner's Manual* or *Product Information Guide*.

1. [Shut down the computer](#) through the **Start** menu.
2. Ensure that your computer and attached devices are turned off. If your computer and attached devices did not automatically turn off when you shut down your computer, turn them off now.

 **NOTICE:** To disconnect a network cable, first unplug the cable from your computer and then unplug it from the network wall jack.

3. Disconnect any telephone or telecommunication lines from the computer.
4. Disconnect your computer and all attached devices from their electrical outlets, and then press the power button to ground the system board.

 **CAUTION:** To guard against electrical shock, always unplug your computer from the electrical outlet before opening the cover.

5. [Remove the computer cover](#).

 **NOTICE:** Before touching anything inside your computer, ground yourself by touching an unpainted metal surface, such as the metal at the back of the computer. While you work, periodically touch an unpainted metal surface to dissipate any static electricity that could harm internal components.

6. [Remove the floppy drive](#).
7. [Remove any cards](#) that are installed.
8. Disconnect all cables from the system board.
9. Lift up the heat-sink shroud.

 **CAUTION:** The microprocessor heat sink can get hot. To avoid burns, ensure that the heat sink has had sufficient time to cool before you touch it.

10. [Remove the microprocessor heat sink](#).
11. Remove the fan assembly.
12. Remove the 12 screws that secure the system board to the computer frame.

Four of the 12 screws that secure the system board to the computer frame also secure the heat-sink base to the system board.

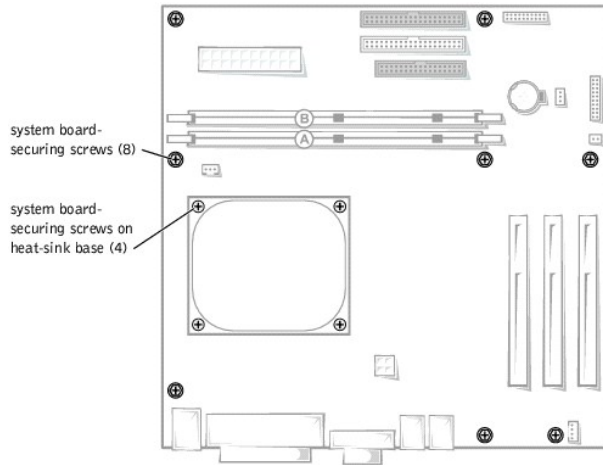

13. Lift the system board out from the computer.
14. Place the system board that you just removed next to the replacement system board.

Visually compare the replacement system board to the existing system board to ensure that you have the correct part.

Installing the System Board

1. Transfer components from the existing system board to the replacement system board:
 - a. [Remove the memory modules and install them](#) on the replacement board.

⚠ CAUTION: The microprocessor package can get hot. To avoid burns, ensure that the package has had sufficient time to cool before you touch it.

- b. [Remove the microprocessor package](#) from the existing system board and transfer it to the replacement system board.
2. Configure the settings of the replacement system board.

Set the jumpers on the replacement system board so that they are identical to the ones on the existing board.

3. Place the system board inside the computer frame, place the heat-sink base on the system board, and then replace the screws that you removed in [step 12](#) of the preceding procedure.
4. Reinstall the fan assembly.
5. [Reinstall the microprocessor heat sink](#), and then lower the heat-sink shroud.
6. Reattach the cables to the system board.
7. [Reinstall any cards](#).
8. [Replace the floppy drive](#).
9. [Replace the computer cover](#).

➡ NOTICE: To connect a network cable, first plug the cable into the network wall jack and then plug it into the computer.

10. Connect your computer and devices to electrical outlets, and turn them on.
-

[Back to Contents Page](#)

[Back to Contents Page](#)

System Setup Program

Dell™ Dimension™ 2400 Series

- [Overview](#)
 - [Entering the System Setup Program](#)
 - [Clearing Forgotten Passwords](#)
-

Overview

The system setup program contains the standard settings for your computer.

 **NOTICE:** Unless you are an expert computer user, do not change the settings for this program. Certain changes might make your computer work incorrectly.

You can use the system setup program as follows:

- 1 To change the system configuration information after you add, change, or remove any hardware in your computer
- 1 To set or change user-selectable options—for example, the user password

Dell recommends that you write down the system setup program screen information for future reference.

Entering the System Setup Program

1. Turn on (or restart) your computer.
2. When F2 = Setup, F12 = Boot Menu appears in the upper-right corner of the screen, press <F12>.

If you wait too long and the operating system logo appears, continue to wait until you see the Microsoft® Windows® desktop. Then [shut down your computer](#) and try again.

See the following figure for an example of the main program screen.

| Dell - Dimension 2400 | |
|---|--|
| Intel® Celeron® Processor: <i>xxx</i> GHz Level 2 Cache: <i>xxx</i> KB Integrated | BIOS Version: <i>xxx</i> Service Tag: <i>xxxxxx</i> |
| System Time00:00:00 System DateDY/MO/DATE/YR Drive Configuration<Enter> Boot Sequence<Enter> Memory Information<Enter> CPU Information<Enter> Integrated Devices (LegacySelect Options)<Enter> Power Management<Enter> System Security<Enter> Keyboard NumLockOn Report Keyboard ErrorsReport Auto Power OnDisabled Fast BootOn OS Install ModeOff IDE Hard Drive Acoustics ModeBypass System Event Log<Enter> Asset Tag <i>xxxxxxx</i> | |
| ↑↓ to select | SPACE, +, - to change |
| ESC to exit | F1 = Help |

System Setup Screens

The system setup program screens display the current configuration information for your computer. Information on the screen is divided into five areas:

- 1 Title — The box at the top of all screens that lists the computer name.
- 1 Computer data — Two boxes below the title box that display your computer processor, L2 cache, service tag, and the version number of the BIOS.
- 1 Options — A scrollable box listing options that define the configuration of your computer, including installed hardware, power conservation, and security features.

Fields to the right of the option titles contain settings or values. When <Enter> appears to the right of an option title, press <Enter> to access a popup menu of additional options.

- 1 Key functions — A line of boxes across the bottom of all screens that lists keys and their functions within system setup.
- 1 Help — Press <F1> for information on the option that is selected (highlighted).

| Option | Function |
|--|---|
| System Time | Displays the system time. |
| System Date | Displays the system date. |
| Drive Configuration | Displays drive configurations when <Enter> is pressed. |
| Boot Sequence | Displays boot sequence when <Enter> is pressed. |
| Memory Information | Displays amount of system memory when <Enter> is pressed. |
| CPU Information | Displays CPU information when <Enter> is pressed. |
| Integrated Devices (Legacy Select Options) | Displays integrated device options when <Enter> is pressed. |
| Power Management | Displays power management options when <Enter> is pressed. |
| System Security | Displays system security options when <Enter> is pressed. |
| Keyboard Numlock | Turns the Keyboard NumLock option on and off. The default is On . |
| Report Keyboard Errors | Displays keyboard errors when set to Report . The default is Report . |
| Auto Power On | Allows auto power-on. The default is Disabled . |
| Fast Boot | Turns the fast boot option on and off. The default is On . |
| OS Install Mode | Turns the OS Install Mode on and off. The default is Off . |
| IDE Hard Drive Acoustics Mode | Sets the performance speed of your hard drive. The default is Bypass . |
| System Event Log | Displays the system event log when <Enter> is pressed. |
| Asset Tag | Displays asset tag information. |

The following table shows **Drive Configuration** option information.

| | |
|--------------------|---|
| Diskette Drive A: | Displays floppy drive details. |
| Primary Drive 0: | Displays primary hard drive 0. The default is Auto . |
| Primary Drive 1: | Displays primary hard drive 1 (if installed). The default is Off . |
| Secondary Drive 0: | Displays secondary hard drive 0. The default is Auto . |
| Secondary Drive 1: | Displays secondary hard drive device type. The default is Off . |
| IDE Drive UDMA: | Turns IDE Drive UDMA on and off. The default is On . |

The following table shows **Memory Information** option information.

| Option | Function |
|----------------------------|--|
| Installed System Memory | Displays the amount of installed system memory. |
| System Memory Speed | Displays the speed of your system memory. |
| System Memory Channel Mode | Displays the mode of your system memory. |
| AGP Aperture | Displays the amount of aperture memory. The default is 128 MB . |

The following table shows **CPU Information** option information.

| Option | Function |
|-----------------|---|
| Hyper-Threading | Enables Hyper-Threading. The default is Disabled . |
| CPU Speed | Sets the CPU speed. The default is Normal . |
| Bus Speed | Displays the bus speed. |
| Processor 0 ID | Displays processor ID. |
| Clock Speed | Displays clock speed. |
| Cache Size | Displays cache size. |

The following table shows **Integrated Devices (Legacy Select Options)** option information.

| Option | Function |
|------------------------------|---|
| Sound | Turns the integrated sound off and on. The default is On . |
| Network Interface Controller | Turns the network interface controller off and on. The default is On . |
| Mouse Port | Turns the mouse port off and on. The default is On . |
| USB Emulation | Turns USB emulation off and on. The default is On . |
| USB Controller | Turns the USB controller off and on. The default is On . |
| Serial Port 1 | Sets serial port options and turns the port off and on. The default is Auto . |
| Parallel Port | Displays parallel port settings when <Enter> is pressed. The default mode is PS/2 and the I/O address default is 378h . |
| Diskette Interface | Sets the floppy drive interface options. The default is Auto . |
| Primary Video Controller | Sets the primary video controller. The default is AGP . |

The following table shows **Power Management** option information.

| Option | Function |
|-------------------|--|
| Suspend Mode | Displays the suspend state used by the computer. The default is S3 . |
| AC Power Recovery | Enables AC power recovery to occur. The default is Off . |
| Low Power Mode | Minimizes power use when the computer is off. The default is Disabled . |

The following table shows **System Security** option information.

| Option | Function |
|-----------------|---|
| Password Status | Locks and unlocks the password option. The default is Unlocked . |
| System Password | Enables and disables the system password. The default is Not enabled . |
| Setup Password | Enables and disables the setup password. The default is Not enabled . |

| | |
|------------------------|--|
| POST Hotkeys | Selects key that are active during POST. The default is F2 and F12 . |
| PXE BIS Default Policy | Specifies how the computer will respond to boot integrity services authentication requests when no certificate has been installed. When set to Deny (the default), the request is rejected. The request is accepted when set to Accept . |

Boot Sequence

This feature allows you to change the boot sequence for devices.

Changing Boot Sequence for the Current Boot

You can use this feature, for example, to restart your computer to a USB device such as a floppy drive, memory key, or CD-RW drive.

1. Turn on (or restart) your computer.
2. When F2 = Setup, F12 = Boot Menu appears in the upper-right corner of the screen, press <F12>.

If you wait too long and the operating system logo appears, continue to wait until you see the Microsoft Windows desktop. Then [shut down your computer](#) and try again.

The Boot Device Menu appears, listing all available boot devices. Each device has a number next to it.

3. At the bottom of the menu, enter the number of the device that is to be used for the current boot only.

Changing Boot Sequence for Future Boots

1. Enter the system setup program.
2. Use the arrow keys to highlight the Boot Sequence menu option and press <Enter> to access the pop-up menu.

 **NOTE:** Write down your current boot sequence in case you want to restore it.

3. Press the up- and down-arrow keys to move through the list of devices.
4. Press the spacebar to enable or disable a device (enabled devices have a checkmark).

Press plus (+) or minus (-) to move a selected device up or down the list.

Clearing Forgotten Passwords

 **CAUTION:** Before you begin any of the procedures in this section, follow the safety instructions in your *Owner's Manual* or *Product Information Guide*.

 **CAUTION:** To guard against electrical shock, always unplug your computer from the electrical outlet before opening the cover.

1. [Shut down the computer](#) through the **Start** menu.

 **NOTICE:** To disconnect a network cable, first unplug the cable from your computer and then unplug it from the network wall jack.

2. Turn off any attached devices and disconnect them from their electrical outlets.
3. Disconnect the computer power cable from the wall outlet, and then press the power button to ground the system board.
4. [Remove the computer cover](#).
5. Locate the 2-pin password jumper on the [system board](#), and then attach the jumper to both pins.

The jumper is attached to only one pin for shipping.

6. [Replace the computer cover](#).

 **NOTICE:** To connect a network cable, first plug the cable into the network wall jack and then plug it into the computer.

7. Connect your computer and devices to electrical outlets, and then turn them on.
8. If you are prompted to press <F1> to continue, press <F1>.
9. After the Microsoft Windows desktop appears on your computer, [shut down the computer](#).

 **NOTICE:** To disconnect a network cable, first unplug the cable from your computer and then unplug it from the network wall jack.

10. Turn off any attached devices and disconnect them from their electrical outlets.
11. Disconnect the computer power cable from the wall outlet, and then press the power button to ground the system board.
12. [Remove the computer cover.](#)
13. Remove the password jumper.
Attach the jumper to only one pin so that you do not lose it.
14. [Replace the computer cover.](#)

 **NOTICE:** To connect a network cable, first plug the cable into the network wall jack and then plug it into the computer.

15. Connect your computer and devices to electrical outlets, and turn them on.
16. If you are prompted to press <F1> to continue, press <F1>.

[Back to Contents Page](#)

Technical Overview

Dell™ Dimension™ 2400 Series

- [Looking Inside Your Computer](#)
 - [System Board Components](#)
 - [Power Supply DC Connector Pin Assignments](#)
-

Looking Inside Your Computer

⚠ CAUTION: Before you begin any of the procedures in this section, follow the safety instructions in your *Owner's Manual* or *Product Information Guide*.

⚠ CAUTION: To guard against electrical shock, always unplug your computer from the electrical outlet before opening the computer cover.

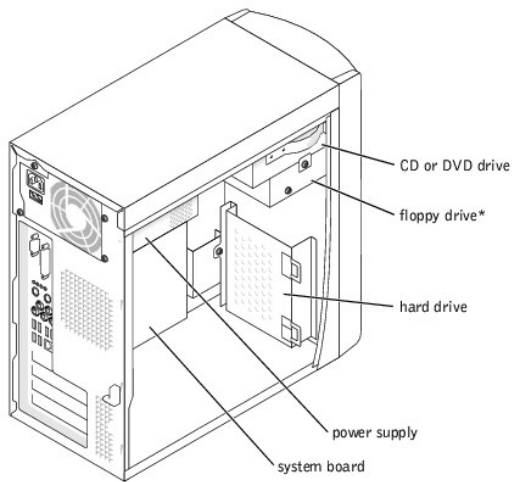

*May not be present on all computers.

System Board Components

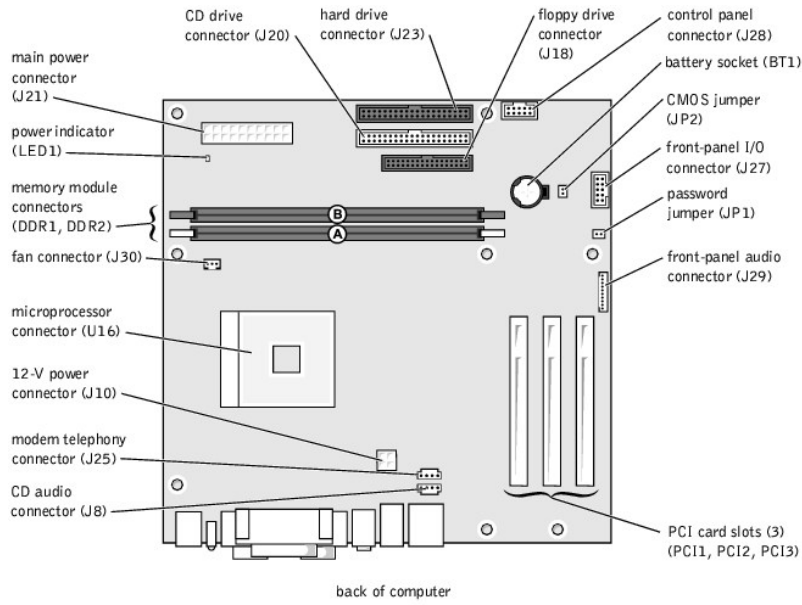

Power Supply DC Connector Pin Assignments

DC Power Connector P1

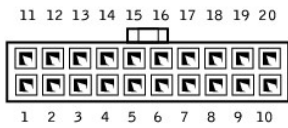

| Pin Number | Signal name | 18-AWG Wire |
|------------|-------------|-------------|
| 1 | +3.3 VDC | Orange |
| 2 | +3.3 VDC | Orange |
| 3 | COM | Black |
| 4 | +5 VDC | Red |
| 5 | COM | Black |
| 6 | +5 VDC | Red |
| 7 | COM | Black |
| 8 | POK* | Gray |
| 9 | +5 VFP | Purple |
| 10 | +12 VDC | Yellow |
| 11 | +3.3 VDC | Orange |
| 12 | -12 VDC* | Blue |
| 13 | COM | Black |
| 14 | PS ON* | Green |
| 15 | COM | Black |
| 16 | COM | Black |
| 17 | COM | Black |
| 18 | - | No connect |
| 19 | +5 VDC | Red |

| | | |
|--|--------|-----|
| 20 | +5 VDC | Red |
| *Use 22-AWG wire instead of 18-AWG wire. | | |

DC Power Connector P2



| Pin Number | Signal Name | 18-AWG Wire |
|------------|-------------|-------------|
| 1 | COM | Black |
| 2 | COM | Black |
| 3 | +12 VDC | Yellow |
| 4 | +12 VDC | Yellow |

DC Power Connectors P3, P5, P6, P8 and P9

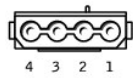

| Pin Number | Signal Name | 18-AWG Wire |
|------------|-------------|-------------|
| 1 | +12 VDC | Yellow |
| 2 | COM | Black |
| 3 | COM | Black |
| 4 | +5 VDC | Red |

DC Power Connector P4

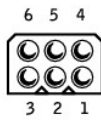

| Pin Number | Signal Name | 22-AWG Wire |
|------------|-------------|-------------|
| 1 | - | No connect |
| 2 | COM | Black |
| 3 | COM | Black |
| 4 | +3.3 VDC | Orange |
| 5 | +5VDC | Red |
| 6 | +12VDC | Yellow |

DC Power Connector P7

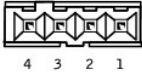

| Pin Number | Signal Name | 22-AWG Wire |
|------------|-------------|-------------|
| 1 | +5 VDC | Red |
| 2 | COM | Black |
| 3 | COM | Black |
| 4 | +12 VDC | Yellow |

[Back to Contents Page](#)

[Back to Contents Page](#)

Turning Off Your Computer

Dell™ Dimension™ 2400 Series

 **NOTICE:** To avoid losing data, turn off your computer by performing a Microsoft® Windows® operating system shutdown, as described in this section, rather than by pressing the power button.

1. Save and close any open files, exit any open programs, click the **Start** button, and then click **Turn Off Computer**.
2. In the **Turn off computer** window, click **Turn off**.

The computer turns off after the shutdown process finishes.

[Back to Contents Page](#)